

Diaphragm Valve, Metal

with integrated automation module

Construction

The GEMÜ 651 piston actuated 2/2-way diaphragm valve is designed for use in sterile applications and has a fully integrated automation module. Normally closed and Normally open control functions are available.

The automation module is available in two versions. Either as a **combi switchbox** with integrated 3/2-way pilot valve for valve actuation and position feedback or with an integrated **electro-pneumatic positioner**. GEMÜ 651 has a microprocessor controlled, intelligent position sensor as well as an integrated analogue travel sensor system. The **Speed-AP** function simplifies commissioning. The base of the actuator housing is made of stainless steel, the cover is made of a stable transparent plastic material.

Features

- Suitable for inert and corrosive* liquid and gaseous media
- Compact design (ideal when space is at a premium)
- CIP cleaning capability
- **Integrated automation module as either**
 - **combi switchbox** or
 - **electro-pneumatic positioner**
- Integrated travel and system control
- AS-Interface field bus connection (option for combi switchbox)

Advantages

- Reduced planning and cabling time
- Integrated air ports
- **Speed-AP** function for fast commissioning
- Optional flow direction
- Installation for an optimized draining is possible
- M5 control air connectors, available in-line with piping or rotated by 90°

*see information on working medium on page 2

Sectional drawing

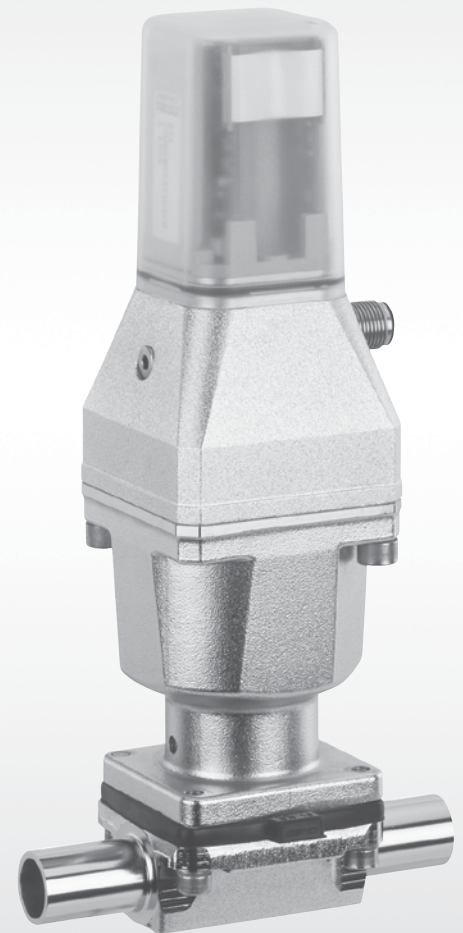
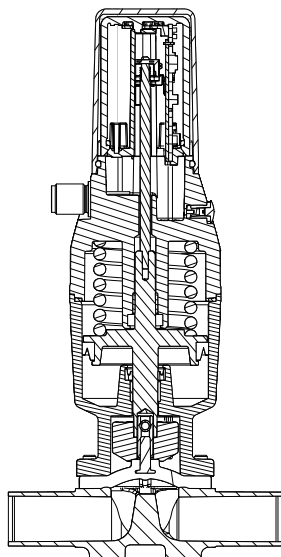

Technical data

Working medium

Corrosive, inert, gaseous and liquid media which have no negative impact on the physical and chemical properties of the body and diaphragm material.

The valve will seal in both flow directions up to full operating pressure (gauge pressure).

Temperatures

Medium temperature	-10 ... 100 °C
Ambient temperature	
Actuator size 0/1	0 ... +60 °C
Actuator size 2	0 ... +50 °C
Max. permissible temperature of control medium	
Actuator size 0/1	60 °C
Actuator size 2	50 °C
Flow rate of pilot valve (at 6 bar)	
Actuator size 0/1	15 l/min
Actuator size 2	100 l/min
Sterilisation temperature ⁽¹⁾	
EPDM (Code 13/3A)	max. 150 °C ⁽²⁾ , max. 60 min per cycle
EPDM (Code 17)	max. 150 °C ⁽²⁾ , max. 180 min per cycle
PTFE/EPDM (Code 54)	max. 150 °C ⁽²⁾ , no time limit per cycle
PTFE/EPDM (Code 5M)	max. 150 °C ⁽²⁾ , no time limit per cycle

¹ The sterilisation temperature is valid for steam (saturated steam) or superheated water.

² If the sterilisation temperatures listed above are applied to the EPDM diaphragms for longer periods of time, the service life of the diaphragms will be reduced. In these cases, maintenance cycles must be adapted accordingly. This also applies to PTFE diaphragms exposed to high temperature fluctuations.

PTFE diaphragms can also be used as moisture barriers; however, this will reduce their service life.

The maintenance cycles must be adapted accordingly.

GEMÜ 555 and 505 globe valves are particularly suitable for use in the area of steam generation and distribution.

The following valve arrangement for interfaces between steam pipes and process pipes has proven itself over time:

A globe valve for shutting off steam pipes and a diaphragm valve as an interface to the process pipes.

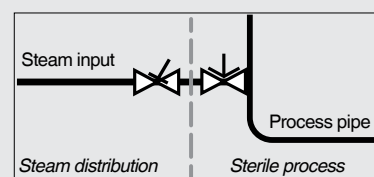

Control medium

Quality classes to DIN ISO 8573-1

Actuator size 0/1	
Dust content	Class 3 (max. particle size 5 µm), (max. particle density 5 mg/m ³)
Pressure dew point	Class 3 (max. pressure dew point -20 °C)
Oil concentration	Class 3 (max. oil concentration 1 mg/m ³)
Actuator size 2	
Dust content	Class 3 (max. particle size 5 µm), (max. particle density 5 mg/m ³)
Pressure dew point	Class 4 (max. pressure dew point 3 °C)
Oil concentration	Class 5 (max. oil concentration 25 mg/m ³)

Filling volume

Actuator size 0:	0.028 dm ³
Actuator size 1:	0.071 dm ³
Actuator size 2:	0.239 dm ³

Materials

Actuator housing	Cover: PP Base: 1.4408
------------------	---------------------------

Technical data

General information	
Protection class	IP 65 / IP 67*
Electrical protection class	III
Mounting position	Optional
Directives	
EMC directive	2004/108/EG
Interference resistance	EN61000-6-2
Interference emission Automation module B2	EN61000-6-4 (class B)
Interference emission Automation module F0/F1	EN61000-6-4 (class A)
Low voltage directive	2006/95/EG

* IP 67 is achieved by piping away the exhausting air. Replace threaded exhaust air plugs by M5 adapter (1434 000 Z2) for this purpose.

		Operating pressure		Control pressure		Actuator weight
Diaphragm size	DN	EPDM	PTFE	C.f. 1	C.f. 2	[g]
8	4 ... 15	0 - 10 bar	0 - 6 bar	3.5 - 7 bar	max. 4.5 bar	1000
10	10 ... 15	0 - 10 bar	0 - 6 bar	4.5 - 7 bar	max. 4.5 bar	1500
25	15 ... 25	0 - 10 bar	0 - 6 bar	5.0 - 7 bar	max. 4.5 bar	3800

All pressures are gauge pressures. Operating pressure values were determined with static operating pressure applied on one side of a closed valve. Sealing at the valve seat and atmospheric sealing is ensured for the given values. Information on operating pressures applied on both sides and for high purity media on request.

Kv values [m ³ /h]								
Pipe standard	DIN	EN 10357 series B (formerly DIN 11850 series 1)	EN 10357 series A (formerly DIN 11850 series 2) / DIN 11866 series A	DIN 11850 Series 3	SMS 3008	ASME BPE / DIN 11866 series C	ISO 1127 / EN 10357 series C / DIN 11866 series B	DIN ISO 228
Connection code	0	16	17	18	37	59	60	1
MG	DN							
8	4	0.5	-	-	-	-	-	-
	6	-	-	1.1	-	-	-	1.2
	8	-	-	1.3	-	-	0.6	2.2
	10	-	2.1	2.1	2.1	-	1.3	-
	15	-	-	-	-	-	2.0	-
10	10	-	2.4	2.4	2.4	-	2.2	3.3
	12	-	-	-	-	-	-	3.2
	15	3.3	3.8	3.8	3.8	-	2.2	4.0
	20	-	-	-	-	-	3.8	-
25	15	4.1	4.7	4.7	4.7	-	-	7.4
	20	6.3	7.0	7.0	7.0	-	4.4	13.2
	25	13.9	15.0	15.0	15.0	12.6	12.2	16.2

MG = diaphragm size

Kv values determined acc. to DIN EN 60534, inlet pressure 5 bar, Δp 1 bar, stainless steel valve body (forged body) and soft elastomer diaphragm. The Kv values for other product configurations (e.g. other diaphragm or body materials) may differ. In general, all diaphragms are subject to the influences of pressure, temperature, the process and their tightening torques. Therefore the Kv values may exceed the tolerance limits of the standard.

The Kv value curve (Kv value dependent on valve stroke) can vary depending on the diaphragm material and duration of use.

Automation module E0, combi switchbox

Electrical data

Power supply

Power supply U_V

$U_V = 24V\ DC \pm 10\%$

Current consumption

$I_{typ.} = 40\ mA\ (at\ 24V\ DC)$

Reverse battery protection

Yes

Electrical connection

Electrical connection

M12 5-pin plug (A-coded)

Optical indication - Automation module E0

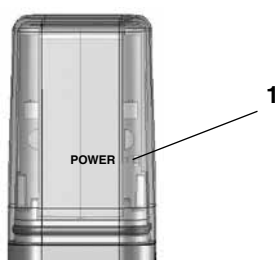

LED	Designation	Colour
1	POWER	yellow

Electrical connections - Automation module E0

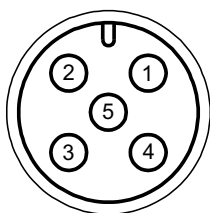

Connection	Pin	Signal name
X 1 A-coded M12 plug	1	U+, 24V DC pilot valve
	2	n.c.
	3	GND
	4	n.c.
	5	n.c.

Automation module B2, combi switchbox with AS-Interface

Electrical data

Power supply

Power supply U_V

26.5 ... 31.6V DC acc. to AS-Interface specification

Current consumption

max. 120 mA

Rating

Continuously rated

Reverse battery protection

Yes

Electrical connection

Electrical connection

M12 5-pin plug (A-coded)

AS-Interface profile

AS-Interface specification

3.0; max. 62 slaves

AS-Interface profile

S 7.A.E

I/O configuration

7

ID-Code

A

ID2-Code

E

Approvals

AS-Interface certificate

Certificate no.: 65202



Inputs / outputs

Inputs AS-Interface (as seen from the AS-Interface master)		
Bit	Function	Logic
DI0	Indication of Open position	0 = process valve not in Open position 1 = process valve in Open position
DI1	Indication of Closed position	0 = process valve not in Closed position 1 = process valve in Closed position
DI2	Indication of operating mode	0 = normal operation 1 = programming mode
DI3	Error 2	see table: Error analysis
FID	Error 1	see table: Error analysis
Outputs AS-Interface (as seen from the AS-Interface master)		
Bit	Function	Logic
DO0	Activation of pneum. outlet 2/4 (c.f. 1 and 2) (activation of pilot valve Y1/Y2)	0 = pneum. outlet 2 vented/outlet 4 pressurized 1 = pneum. outlet 2 pressurized/ outlet 4 vented
DO1	Selection of programming mode	0 = manual programming 1 = automatic programming
DO2	Selection of operating mode	0 = normal operation 1 = programming mode
DO3	not available	
Parameter outputs		
Bit	Function	Logic
P0	Setting of switch points	see table: Switch points
P1	Setting of switch points	see table: Switch points
P2	Setting of switch points	see table: Switch points

Switch points

P2	P1	P0	Switch point OPEN [%]	Switch point CLOSED [%]
0	0	0	12	25
0	0	1	25	25
0	1	0	6	12
0	1	1	12	12
1	0	0	25	12
1	0	1	6	6
1	1	0	12	6
1	1	1	25	6

Switch points: The data in the table refers to the percentage of travel before the programmed switching point at which the switch will transmit the position is achieved.

Error analysis

Error 1	Error 2	Error function
1	0	Internal error
0	1	Programming error
1	1	Sensor error

Optical indication - Automation module B2

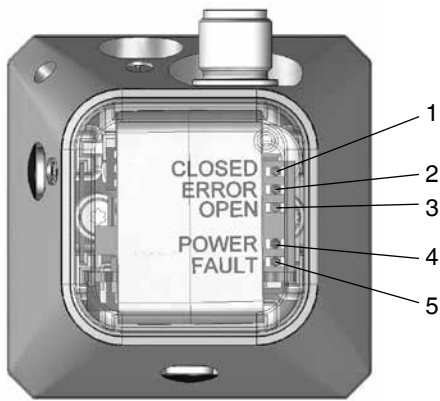

LED	Designation	Colour
1	CLOSED	orange
2	ERROR	red
3	OPEN	yellow
4	POWER	green
5	FAULT	red

Electrical connections - Automation module B2

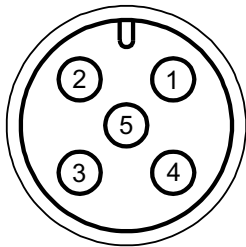

Automation module B2		
Connection	Pin	Signal name
X 1 A-coded M12 plug	1	AS-Interface +
	2	n.c.
	3	AS-Interface -
	4	n.c.
	5	n.c.

Automation module F0/F1, positioner

Electrical data

Power supply

Power supply U_V

Current consumption

$U_V = 24V\ DC\ +10\% / -5\%$
 $I_{typ.} = 70\ mA\ (at\ 24V\ DC)$

Analogue input

Accuracy

Set value input

$\leq 0.3\ \%$
 $4-20\ mA$

Digital input

Initialisation input

Voltage

Level "Logical 1"

Level "Logical 0"

Input current

$U_{rated} = 24V\ DC$
 $14V\ DC \leq U_H \leq 28V\ DC$
 $0V\ DC \leq U_L \leq 8V\ DC$
 $I_{typ.} = 2.5\ mA\ (at\ 24V\ DC)$

Electrical connection

Electrical connection

Positioner data

System deviation

Initialisation

M12 5-pin plug (A-coded)

$\leq 1\ \%$
 Automatic via 24V DC signal

Display elements

Status display

Analogue (Automation module F1)

Accuracy / Linearity

Temperature drift

Resolution

Actual value output

Output

4 visible LEDs

$\leq \pm 1,0\ \%\ v.E.$

$\leq \pm 0,5\ \%\ v.E.$

12 bit

4 - 20 mA

aktiv

Optical indication - Automation module F0/F1

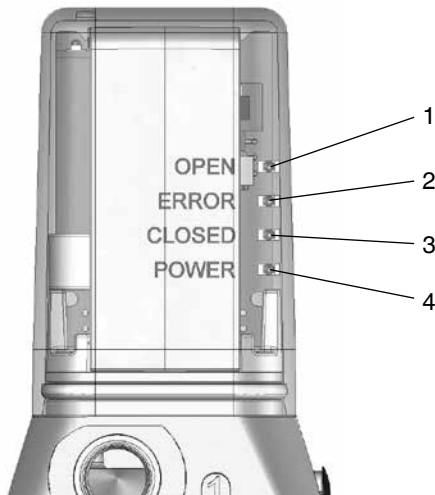

LED	Designation	Colour
1	OPEN	yellow
2	ERROR	red
3	CLOSED	orange
4	POWER	yellow

Electrical connections - Automation module F0/F1

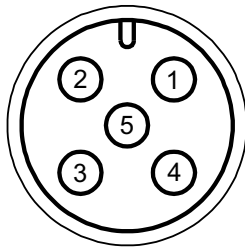

Automation module F0/F1

Connection	Pin	Signal name
X 1 A-coded M12 plug	1	Uv, 24 V DC supply voltage
	2	I+, 4-20 mA set value input
	3	I- / Uv GND
	4	I+, 4-20 mA actual value output (only automation module F1)
	5	Uv, initialisation 24 V DC, initialisation is started by impulse signal $t \geq 100$ ms

Actuator dimensions - GEMÜ 9651

Actuator size	Diaphragm size	A1	A2	A3	B	B2
0	8	160	72.0	85.0	49	35
1	10	185	96.5	109.5	60	36
2	25	182	140.0	116.5	91	59

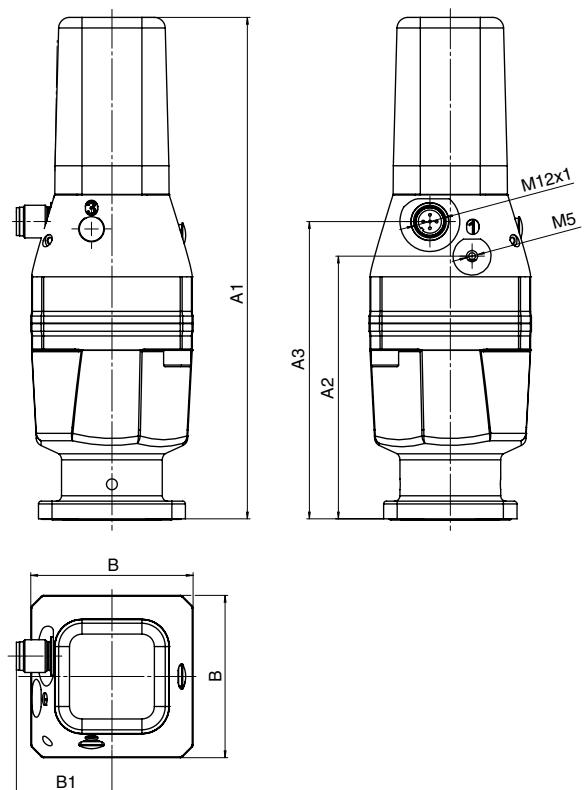

Order data (2/2-way valves)

Body configuration	Code
Tank bottom valve body	B**
2/2-way body	D
T body	T*

* For dimensions see T Valves brochure

** Dimensions and versions on request or according to customer requirements

Connection	Code
Butt weld spigots	
Spigots DIN	0
Spigots EN 10357 series B (formerly DIN 11850 series 1)	16
Spigot EN 10357 series A (formerly DIN 11850 series 2) / DIN 11866 series A	17
Spigots DIN 11850 series 3	18
Spigots JIS-G 3447	35
Spigots JIS-G 3459	36
Spigots SMS 3008	37
Spigots BS 4825 Part 1	55
Spigot ASME BPE / DIN 11866 series C	59
Spigot ISO 1127 / EN 10357 series C / DIN 11866 series B	60
Spigots ANSI/ASME B36.19M Schedule 10s	63
Spigots ANSI/ASME B36.19M Schedule 5s	64
Spigots ANSI/ASME B36.19M Schedule 40s	65
Threaded connections	
Threaded sockets DIN ISO 228	1
Threaded spigots DIN 11851	6
Cone spigot and union nut DIN 11851	6K
Aseptic unions on request	
Clamp connections	
Clamps ASME BPE for pipe ASME BPE, length ASME BPE	80
Clamps DIN 32676 series B for pipe EN ISO 1127, length EN 558, series 7	82
Clamps ASME BPE for pipe ASME BPE, length EN 558, series 7	88
Clamps DIN 32676 series A for pipe DIN 11850, length EN 558, series 7	8A
Clamps SMS 3017 for pipe SMS 3008, length EN 558, series 7	8E
Clamps DIN 32676 series C, length FTF ASME BPE	8P
Clamps DIN 32676 series C, length FTF EN 558 series 7	8T
Aseptic clamps on request	
For overview of available valve bodies see page 14	

Valve body material	Code
1.4435, investment casting	C3
1.4408, investment casting	37
1.4435 (316L), forged body	40
1.4435 (BN2), forged body Δ Fe<0,5%	42
1.4539, forged body	F4

Diaphragm material	Code
EPDM	13 3A*
EPDM	17
EPDM	19
EPDM	36
PTFE/EPDM, one-piece	54
PTFE/EPDM, two-piece	5M**
* for diaphragm size 8	
** Code 5M available from diaphragm size 10	
Material complies with FDA requirements	

Control function	Code
Normally closed (NC)	1
Normally open (NO)	2

Actuator size	Code
Actuator size 0 (Diaphragm size 8)	0
Actuator size 1 (Diaphragm size 10)	1
Actuator size 2 (Diaphragm size 25)	2

Design (actuator)	Code
Connection in flow direction	T
Connection 90° to flow direction	R

Spring set	Code
Diaphragm size 8 C.f. 1	A
Diaphragm size 8 C.f. 2	1
Diaphragm size 10 C.f. 1+2	1
Diaphragm size 25 C.f. 1+2	1

Automation module	Code
Combi switchbox with integrated pilot valve and status LED	E0
Combi switchbox with integrated pilot valve, OPEN / CLOSED position feedback and Speed ^{AP} function, AS-Interface, 62 slaves, Spec. 3.0	B2
Positioner with Speed-AP function, set value input 4-20 mA	F0
Positioner with Speed-AP function, set value input 4-20 mA actual value output 4-20 mA	F1

Order data (2/2-way valves)

Internal surface finishes for forged and block material bodies ¹

Readings for Process Contact Surfaces	Mechanically polished ²		Electropolished	
	Hygienic class DIN 11866	Code	Hygienic class DIN 11866	Code
Ra ≤ 0.80 μm	H3	1502	HE3	1503
Ra ≤ 0.60 μm	-	1507	-	1508
Ra ≤ 0.40 μm	H4	1536	HE4	1537
Ra ≤ 0.25 μm ³	H5	1527	HE5	1516

Readings for Process Contact Surfaces acc. to ASME BPE 2016 ⁴	Mechanically polished ²		Electropolished	
	ASME BPE Surface Designation	Code	ASME BPE Surface Designation	Code
Ra Max. = 0.76 μm (30 μinch)	SF3	SF3	-	-
Ra Max. = 0.64 μm (25 μinch)	SF2	SF2	SF6	SF6
Ra Max. = 0.51 μm (20 μinch)	SF1	SF1	SF5	SF5
Ra Max. = 0.38 μm (15 μinch)	-	-	SF4	SF4

Internal surface finishes for investment cast bodies

Readings for Process Contact Surfaces	Mechanically polished ²	
	Hygienic class DIN 11866	Code
Ra ≤ 6.30 μm	-	1500
Ra ≤ 0.80 μm	H3	1502
Ra ≤ 0.60 μm ⁵	-	1507

¹ Surface finishes of customized valve bodies may be limited in special cases.

² Or any other finishing method that meets the Ra value (acc. to ASME BPE).

³ The smallest possible Ra finish for pipe connections with an internal pipe diameter < 6 mm is 0.38 μm.

⁴ When using these surfaces, the bodies are marked according to the specifications of ASME BPE.

The surfaces are only available for valve bodies which are made of materials (e.g. GEMÜ material codes 40, 41, F4, 44) and use connections (e.g. GEMÜ connection codes 59, 80, 88) according to ASME BPE.

⁵ Not possible for GEMÜ connection code 59, DN 8 and GEMÜ connection code 0, DN 4.

Ra acc. to DIN EN ISO 4288 and ASME B46.1

Order data (2/2-way valves)

Order example	651	15	D	60	40	13	1	2	t	1	B2	1503
Type	651											
Nominal size		15										
Body configuration (code)			D									
Connection (code)				60								
Valve body material (code)					40							
Diaphragm material (code)						13						
Control function (code)							1					
Actuator size (code)								2				
Design (actuator) (code)									t			
Spring set (code)										1		
Automation module (code)											B2	
Surface finish (code)												1503

Body dimensions [mm]

Threaded sockets, connection code 1 Valve body material: Investment casting (code 37)

MG	DN	R	H	H1	t	L	SW2	Number of flats	Weight [kg]
8	8	G 1/4	19.0	9.0	11	72	18	6	0.09
10	12	G 3/8	25.0	13.0	12	55	22	2	0.17
	15	G 1/2	30.0	15.0	15	68	27	2	0.26
25	15	G 1/2	28.3	14.8	15	85	27	6	0.32
	20	G 3/4	33.3	17.3	16	85	32	6	0.34
	25	G 1	42.3	21.8	13	110	41	6	0.39

MG = diaphragm size

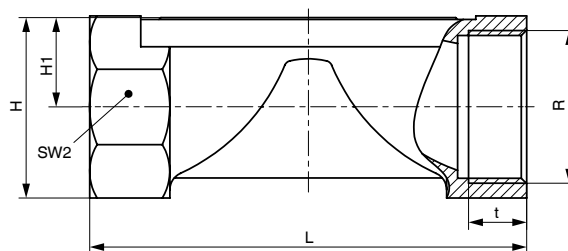

Body dimensions [mm]

Butt weld spigots, connection code 0, 16, 17, 18 Valve body material: Investment casting (code C3), forged body (code 40, F4)

Pipe standard							DIN		EN 10357 series B (formerly DIN 11850 series 1)		EN 10357 series A (formerly DIN 11850 series 2) / DIN 11866 series A		DIN 11850 Series 3		Weight [kg]
Connection code							0		16		17		18		
MG	DN	NPS	L	c	H1*	H1**	ød	s	ød	s	ød	s	ød	s	
8	4	-	72	20	8.5		6	1.0	-	-	-	-	-	-	0.09
	6	-	72	20	8.5		-	-	-	-	8	1.0	-	-	0.09
	8	1/4"	72	20	8.5		-	-	-	-	10	1.0	-	-	0.09
	10	3/8"	72	20	8.5		-	-	12	1.0	13	1.5	14	2.0	0.09
10	10	3/8"	108	25	12.5		-	-	12	1.0	13	1.5	14	2.0	0.30
	15	1/2"	108	25	12.5		18	1.5	18	1.0	19	1.5	20	2.0	0.30
25	15	1/2"	120	25	13.0	19.0	18	1.5	18	1.0	19	1.5	20	2.0	0.62
	20	3/4"	120	25	16.0	19.0	22	1.5	22	1.0	23	1.5	24	2.0	0.58
	25	1"	120	25	19.0	19.0	28	1.5	28	1.0	29	1.5	30	2.0	0.55

* only for investment cast design ** only for forged design MG = diaphragm size
For materials see overview on page 14

Butt weld spigots, connection code 60 Valve body material: Investment casting (code C3), forged body (code 40, F4)

Pipe standard							ISO 1127 / EN 10357 series C / DIN 11866 series B			Weight [kg]
Connection code							60			
MG	DN	NPS	L	c	H1*	H1**	ød	s		
8	6	-	72	20	-	8.5	10.2	1.6	0.09	
	8	1/4"	72	20	8.5	8.5	13.5	1.6	0.09	
	10	3/8"	72	20	-	8.5	-	-	0.09	
10	10	3/8"	108	25	12.5	12.5	17.2	1.6	0.30	
	15	1/2"	108	25	12.5	12.5	21.3	1.6	0.30	
25	15	1/2"	120	25	13.0	19.0	21.3	1.6	0.62	
	20	3/4"	120	25	16.0	19.0	26.9	1.6	0.58	
	25	1"	120	25	19.0	19.0	33.7	2.0	0.55	

* only for investment cast design ** only for forged design MG = diaphragm size
For materials see overview on page 14

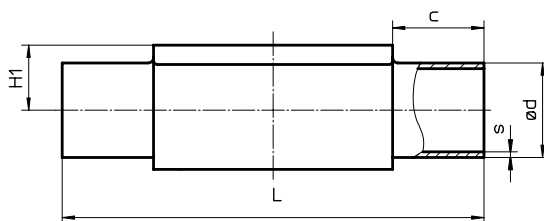

Body dimensions [mm]

Butt weld spigots, connection code 35, 36, 37 Valve body material: Investment casting (code C3), forged body (code 40, F4)

Pipe standard							JIS-G 3447	JIS-G 3459	SMS 3008	Weight [kg]				
Connection code							35		36			37		
MG	DN	NPS	L	c	H1*	H1**	ød	s	ød			s	ød	s
8	6	-	72	20	-	8.5	-	-	10.5	1.20	-	-	0.09	
	8	1/4"	72	20	-	8.5	-	-	13.8	1.65	-	-		
10	10	3/8"	108	25	-	12.5	-	-	17.3	1.65	-	-	0.30	
	15	1/2"	108	25	-	12.5	-	-	21.7	2.10	-	-		
25	15	1/2"	120	25	-	19.0	-	-	21.7	2.10	-	-	0.62	
	20	3/4"	120	25	-	19.0	-	-	27.2	2.10	-	-		
	25	1"	120	25	19.0	19.0	25.4	1.2	34.0	2.80	25.0	1.2		

* only for investment cast design ** only for forged design MG = diaphragm size
For materials see overview on page 14

Butt weld spigots, connection code 55, 59, 63, 64, 65 Valve body material: Investment casting (code C3), forged body (code 40, F4)

Pipe standard							BS 4825 Part 1	ASME BPE / DIN 11866 series C	ANSI/ASME B36.19M Schedule 10s	ANSI/ASME B36.19M Schedule 5s	ANSI/ASME B36.19M Schedule 40s	Weight [kg]						
Connection code							55		59		63			64		65		
MG	DN	NPS	L	c	H1*	H1**	ød	s	ød	s	ød			s	ød	s	ød	s
8	6	-	72	20	-	8.5	-	-	-	-	10.3	1.24	-	-	10.3	1.73	0.09	
	8	1/4"	72	20	8.5	8.5	6.35	1.2	6.35	0.89	13.7	1.65	-	-	13.7	2.24		
	10	3/8"	72	20	8.5	8.5	9.53	1.2	9.53	0.89	-	-	-	-	-	-		
	15	1/2"	72	20	8.5	8.5	12.70	1.2	12.70	1.65	-	-	-	-	-	-		
10	10	3/8"	108	25	-	12.5	9.53	1.2	9.53	0.89	17.1	1.65	-	-	17.1	2.31	0.30	
	15	1/2"	108	25	-	12.5	12.70	1.2	12.70	1.65	21.3	2.11	21.3	1.65	21.3	2.77		
	20	3/4"	108	25	12.5	12.5	19.05	1.2	19.05	1.65	-	-	-	-	-	-		
25	15	1/2"	120	25	-	19.0	-	-	-	-	21.3	2.11	21.3	1.65	21.3	2.77	0.62	
	20	3/4"	120	25	16.0	19.0	19.05	1.2	19.05	1.65	26.7	2.11	26.7	1.65	26.7	2.87		
	25	1"	120	25	19.0	19.0	-	-	25.40	1.65	33.4	2.77	33.4	1.65	33.4	3.38		

* only for investment cast design ** only for forged design MG = diaphragm size
For materials see overview on page 14

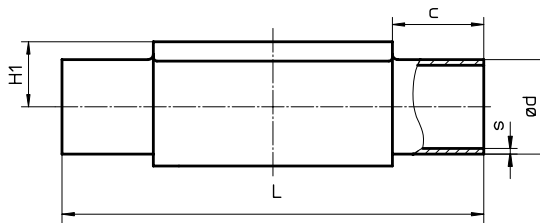

Body dimensions [mm]

Threaded connections, connection code 6 Valve body material: Forged body (code 40)

MG	DN	H1	ød1	Thread to DIN 405 R	L	Weight [kg]
8	10	8.5	10.0	RD 28 x 1/8	92	0.21
10	10	12.5	10.0	RD 28 x 1/8	118	0.33
	15	12.5	16.0	RD 34 x 1/8	118	0.35
25	15	19.0	16.0	RD 34 x 1/8	118	0.71
	20	19.0	20.0	RD 44 x 1/6	118	0.78
	25	19.0	26.0	RD 52 x 1/6	128	0.79

MG = diaphragm size

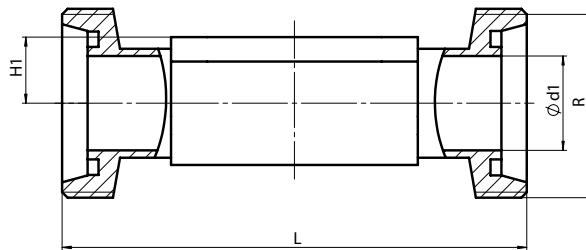

Cone spigot, connection code 6K Valve body material: Forged body (code 40)

MG	DN	H1	ød1	Thread to DIN 405 R	L	Weight [kg]
8	10	8.5	10.0	RD 28 x 1/8	90	0.21
10	10	12.5	10.0	RD 28 x 1/8	116	0.33
	15	12.5	16.0	RD 34 x 1/8	116	0.35
25	15	19.0	16.0	RD 34 x 1/8	116	0.71
	20	19.0	20.0	RD 44 x 1/6	114	0.78
	25	19.0	26.0	RD 52 x 1/6	127	0.79

MG = diaphragm size

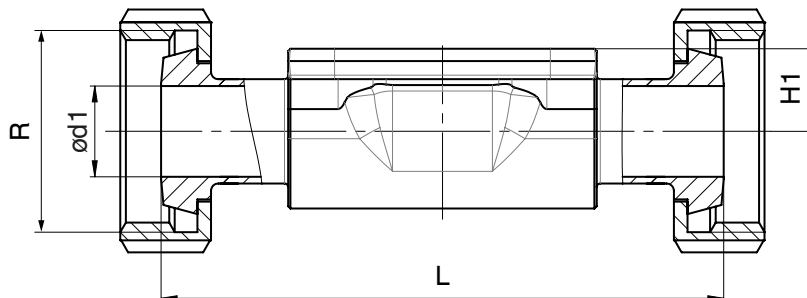

Body dimensions [mm]

Clamp connections, connection code 80, 82, 88, 8A, 8E, 8P, 8T Valve body material: Forged body (code 40, F4)

Pipe connection for clamp			ASME BPE							ISO 1127 / EN 10357 series C / DIN 11866 series B			EN 10357 series A (formerly DIN 11850 series 2) / DIN 11866 series A			SMS 3008			Weight [kg]
Clamp connection			Code 80, 88 - ASME BPE Code 8P, 8T - DIN 32676 series C							DIN 32676 series B			DIN 32676 series A			ISO 2852 / SMS 3017			
Clamp connection code			80, 8P			88, 8T				82			8A			8E			
MG	DN	NPS	H1	ød1	ød3	L	ød1	ød3	L	ød1	ød3	L	ød1	ød3	L	ød1	ød3	L	
8	6	1/8"	8.5	-	-	-	-	-	-	7.0	25.0	63.5	6	25.0	63.5	-	-	-	-
	8	1/4"	8.5	4.57	25.0	63.5	-	-	-	10.3	25.0	63.5	8	25.0	63.5	-	-	-	0.15
	10	3/8"	8.5	7.75	25.0	63.5	-	-	-	-	-	-	10	34.0	88.9	-	-	-	0.18
	15	1/2"	8.5	9.40	25.0	63.5	9.40	25.0	108	-	-	-	-	-	-	-	-	-	0.18
10	10	3/8"	12.5	-	-	-	-	-	-	14.0	25.0	108.0	10	34.0	108.0	-	-	-	0.30
	15	1/2"	12.5	9.40	25.0	88.9	9.40	25.0	108	18.1	50.5	108.0	16	34.0	108.0	-	-	-	0.43
	20	3/4"	12.5	15.75	25.0	101.6	15.75	25.0	117	-	-	-	-	-	-	-	-	-	0.43
25	15	1/2"	19.0	-	-	-	-	-	-	18.1	50.5	108.0	16	34.0	108.0	-	-	-	0.75
	20	3/4"	19.0	15.75	25.0	101.6	15.75	25.0	117	23.7	50.5	117.0	20	34.0	117.0	-	-	-	0.71
	25	1"	19.0	22.10	50.5	114.3	22.10	50.5	127	29.7	50.5	127.0	26	50.5	127.0	22.6	50.5	127	0.63

MG = diaphragm size

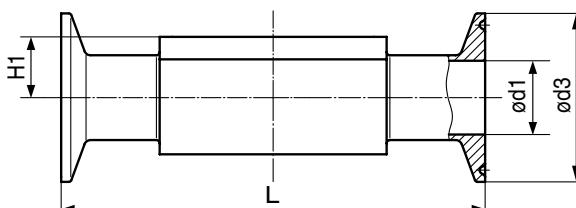

Overview of valve bodies for GEMÜ 651

		Spigots																	
Connection code		0	16	17	18	35	36	37	55	59	60	63	64	65					
Material code		C3	40	40	C3	40	40	40	40	C3	40	40	C3	40	C3	40	40	40	40
MG	DN																		
8	4	X	X	-	-	-	-	-	-	-	-	-	-	-	-	-	-	-	-
	6	-	-	-	X	X	-	-	X	-	-	-	-	-	-	X	X	-	X
	8	-	-	-	X	X	-	-	X	-	-	X	X	X	X	X	X	-	X
	10	-	-	X	X	X	X	-	-	-	-	X	X	X	-	-	-	-	-
10	15	-	-	-	-	-	-	-	-	-	-	X	X	X	-	-	-	-	-
	10	-	-	X	X	X	X	-	X	-	-	X	-	X	X	X	X	-	X
	15	-	X	X	X	X	X	-	X	-	-	X	-	X	X	X	X	X	X
25	20	-	X	X	X	X	X	-	X	-	-	X	X	X	X	X	X	X	X
	15	-	X	X	X	X	X	-	X	-	-	-	-	-	X	X	X	X	X
	25	-	X	X	X	X	X	X	X	X	X	-	X	X	X	X	X	X	X

Availability of material code 42, F4: same as code 40 MG = diaphragm size

		Threaded connections			Clamps			
Connection code		1	6, 6K	80, 8P	82	88, 8T	8A	8E
Material code		37	40	40	40	40	40	40
MG	DN							
8	6	-	-	-	K	-	K	-
	8	X	-	K	K	-	K	-
	10	-	W	K	-	-	W	-
	15	-	-	K	-	W	-	-
10	10	-	W	-	K	-	K	-
	12	X	-	-	-	-	-	-
	15	X	W	K	W	K	K	-
25	20	-	-	K	-	K	-	-
	15	X	W	-	W	-	K	-
	20	X	W	K	K	K	K	-
	25	X	W	K	K	K	K	K

X = Standard
 K = Connections completely machined (not welded)
 W = Welded construction
 Availability of material code 42, F4: same as code 40
 MG = diaphragm size

For further metal diaphragm valves, accessories and other products,
 please see our Product Range catalogue and Price List.
 Contact GEMÜ.

GEMÜ VALVES, MEASUREMENT
 AND CONTROL SYSTEMS

